

WT-SPM14-12-126

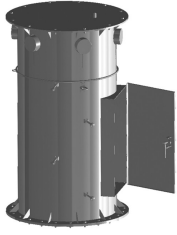

Stackable Pod Mount Assembly, 3-sector platform, 14 ft face, twelve 2-3/8 in OD x 126 in plain end pipes included

Product Classification

Product Type Water tower mount

General Specifications

Mounting Hatch plate

Pipe, quantity 12

Sectors, quantity 3

Dimensions

Height 3,200.4 mm | 126 in

Face Width 4.42 m | 14.5 ft

Width 4,419.6 mm | 174 in

Length 4,419.6 mm | 174 in

Pipe Length 3,200.4 mm | 126 in

Compatible Diameter 1,219.2 mm | 48 in

Pipe Outer Diameter 60.96 mm | 2.4 in

WT-SPM14-12-126

Outline Drawing

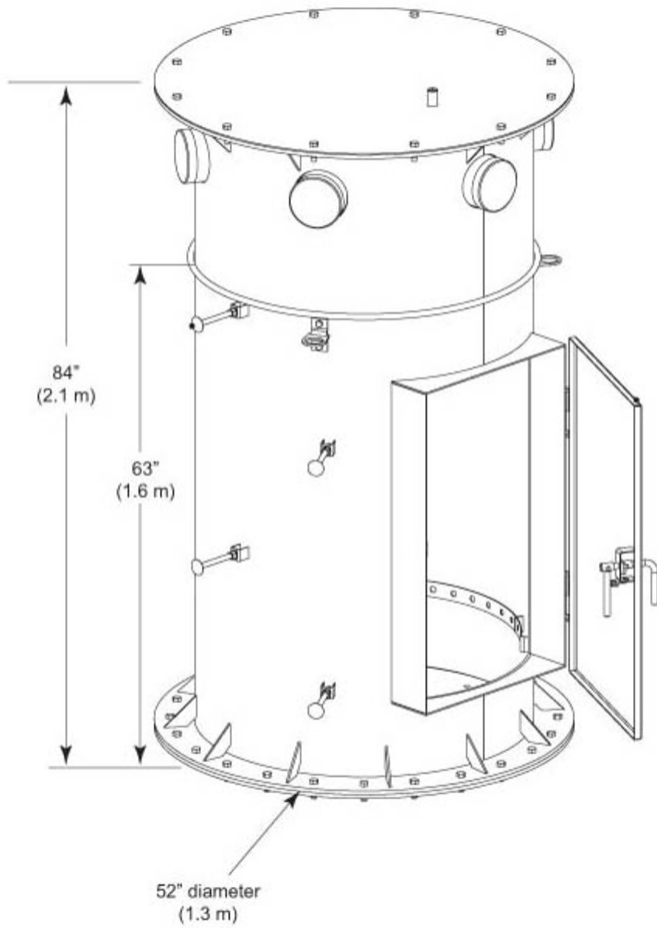

Material Specifications

Material Type Hot dip galvanized steel

Packaging and Weights

Included Mount | Plain end pipes (12) | Platform

Packaging quantity 1

Weight, net 1,465.602 kg | 3,231.1 lb

Regulatory Compliance/Certifications

Agency **Classification**

WT-SPM14-12-126

ISO 9001:2015

Designed, manufactured and/or distributed under this quality management system

Included Products

- | | | |
|-------------|---|--|
| MC-RM3060-3 | - | Universal Ring Mount, 30 in to 60 in OD |
| MT-196-14L | - | Low Profile Co-location Large Base Platform, 14 ft face. Ring Mount & Antenna Pipes Sold Separately. |
| MT-220-120 | - | Pipe Mount Kit, 2-3/8 in OD x 126 in |
| WT-SPM-B | - | Stackable Pod Mount Assembly, platform and plain end pipe not included |

MC-RM3060-3

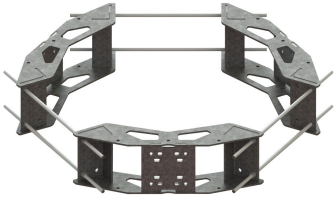

Universal Ring Mount, 30 in to 60 in OD

Product Classification

Product Type Universal ring mount

General Specifications

Mounting Monopole, 762–1524 mm (30–60 in) OD

Pipe, quantity 0

Sectors, quantity 3

Dimensions

Height 254 mm | 10 in

Length 152.4 mm | 6 in

Mounting Diameter, maximum 1524 mm | 60 in

Mounting Diameter, minimum 762 mm | 30 in

Pipe Outer Diameter 0 mm | 0 in

Mounting Circumference, maximum 4,785.36 mm | 188.4 in

Mounting Circumference, minimum 2,392.68 mm | 94.2 in

Material Specifications

Material Type Hot dip galvanized steel

Mechanical Specifications

Wind Rating 140 mph (BWS) at 150 ft AGL | 160 mph (3-second gust) at 150 ft AGL using Exposure D per FBC

Wind Rating Criteria Four 72 in x 8 in panel antennas per sector

Wind Rating Test Method TIA/EIA-222

Packaging and Weights

Included Mount | Threaded rod

MC-RM3060-3

Packaging quantity 1
Weight, net 140.614 kg | 310 lb

Regulatory Compliance/Certifications

Agency	Classification
CHINA-ROHS	Above maximum concentration value
ISO 9001:2015	Designed, manufactured and/or distributed under this quality management system
ROHS	Compliant/Exempted
UK-ROHS	Compliant/Exempted



* Footnotes

Wind Rating BWS—Base Wind Speed; FBC—Florida Building Code

MT-196-14L

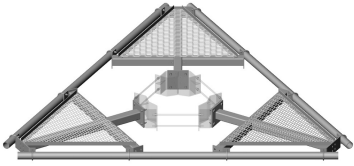

Low Profile Co-location Large Base Platform, 14 ft face. Ring Mount & Antenna Pipes Sold Separately.

Product Classification

Product Type Monopole platform kit

General Specifications

Mounting Ring mount

Sectors, quantity 3

Dimensions

Height 254 mm | 10 in

Face Width 4.42 m | 14.5 ft

Width 4,419.6 mm | 174 in

Length 914.4 mm | 36 in

Pipe Length 0 mm | 0 in

Face Support Pipe Diameter 88.9 mm | 3.5 in

Mounting Diameter, maximum 1524 mm | 60 in

Mounting Diameter, minimum 762 mm | 30 in

Material Specifications

Material Type Hot dip galvanized steel

Mechanical Specifications

Wind Rating 120 mph (BWS) at 150 ft AGL | 140 mph (3-second gust) at 150 ft AGL using Exposure D per FBC

Wind Rating Criteria Four 72 in x 8 in panel antennas per sector

Wind Rating Test Method TIA/EIA-222

Packaging and Weights

Included Platform

Packaging quantity 1

MT-196-14L

Weight, net 581.006 kg | 1,280.9 lb

Regulatory Compliance/Certifications

Agency	Classification
ISO 9001:2015	Designed, manufactured and/or distributed under this quality management system

* Footnotes

Wind Rating BWS—Base Wind Speed; FBC—Florida Building Code

MT-220-120

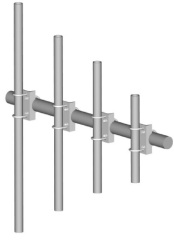

Pipe Mount Kit, 2-3/8 in OD x 126 in

Product Classification

Product Type Pipe mount kit

General Specifications

Mounting Pipe, 88.9 mm (3-1/2 in) OD

Pipe, quantity 1

Dimensions

Height 3,200.4 mm | 126 in

Width 127 mm | 5 in

Length 127 mm | 5 in

Pipe Length 3,200.4 mm | 126 in

Pipe Outer Diameter 60.96 mm | 2.4 in

Material Specifications

Material Type Hot dip galvanized steel

Packaging and Weights

Included Crossover bracket | Plain end pipes | U-bolts

Packaging quantity 1

Weight, net 22.1 kg | 48.722 lb

Regulatory Compliance/Certifications

Agency	Classification
ISO 9001:2015	Designed, manufactured and/or distributed under this quality management system

WT-SPM-B

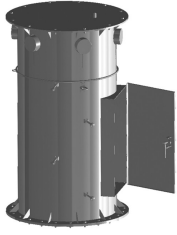

Stackable Pod Mount Assembly, platform and plain end pipe not included

Product Classification

Product Type Water tower mount

General Specifications

Mounting Hatch plate

Dimensions

Height 1,320.8 mm | 52 in

Width 1,320.8 mm | 52 in

Length 2,133.6 mm | 84 in

Compatible Diameter 1,219.2 mm | 48 in

Pipe Outer Diameter 1,066.8 mm | 42 in

WT-SPM-B

Outline Drawing

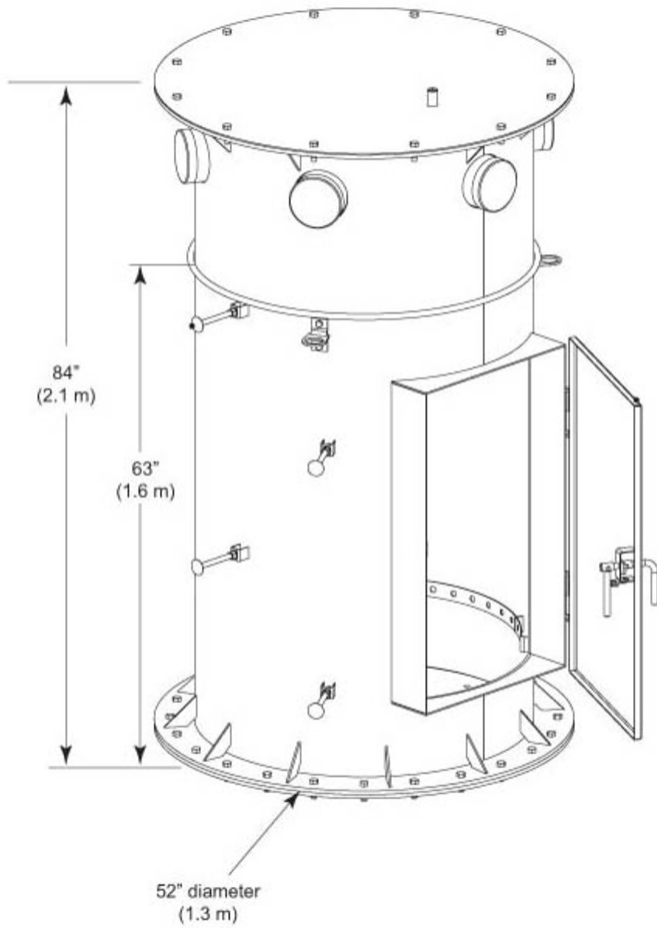

Material Specifications

Material Type Hot dip galvanized steel

Packaging and Weights

Included Hardware | Mount

Packaging quantity 1

Weight, net 603.822 kg | 1,331.2 lb

Regulatory Compliance/Certifications

Agency **Classification**

WT-SPM-B

CHINA-ROHS	Above maximum concentration value
ISO 9001:2015	Designed, manufactured and/or distributed under this quality management system
ROHS	Compliant/Exempted
UK-ROHS	Compliant/Exempted

