

WT-RTA12-9-96

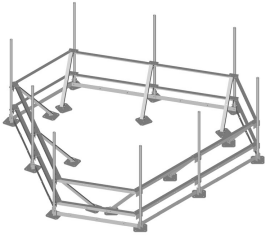

Water Tower Rooftop Assembly, 3-sector, 12 ft face, nine 2-3/8 in OD x 96 in plain end pipes included

Product Classification

Product Type Water tower mount

General Specifications

Mounting Weld-on feet

Pipe, quantity 9

Sectors, quantity 3

Dimensions

Height 2,438.4 mm | 96 in

Face Width 3.81 m | 12.5 ft

Width 4,267.2 mm | 168 in

Length 4,267.2 mm | 168 in

Pipe Length 2,438.4 mm | 96 in

Pipe Outer Diameter 60.96 mm | 2.4 in

WT-RTA12-9-96

Outline Drawing

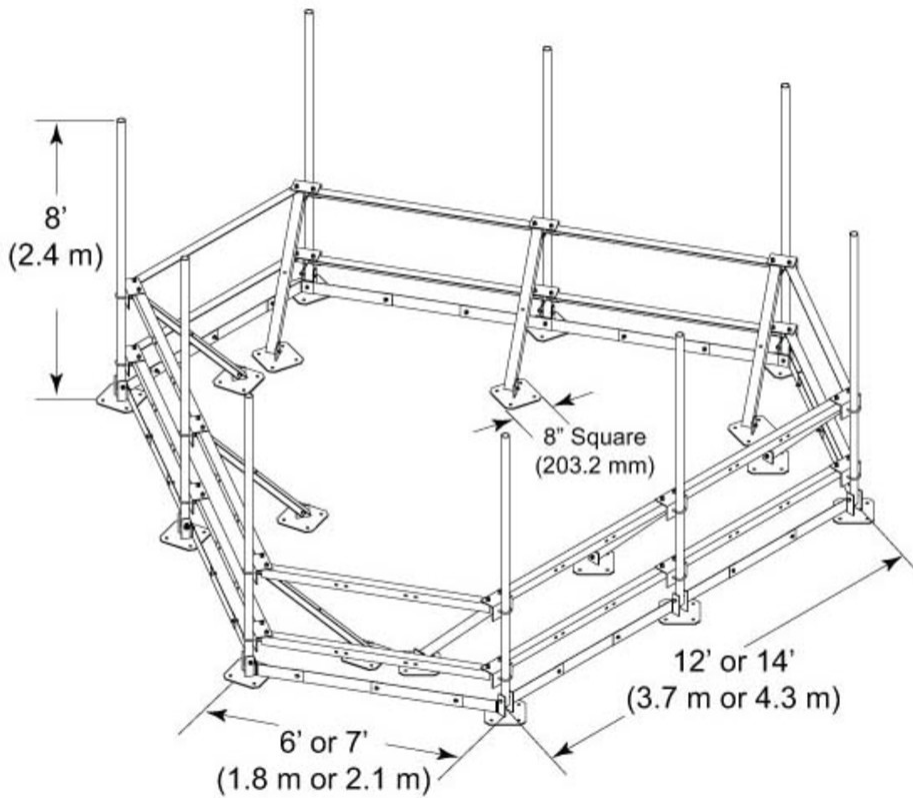

Material Specifications

Material Type Hot dip galvanized steel

Packaging and Weights

Included Mount | Plain end pipes (9)

Packaging quantity 1

Weight, net 731.781 kg | 1,613.3 lb

Regulatory Compliance/Certifications

Agency

CHINA-ROHS

ISO 9001:2015

REACH-SVHC

Classification

Above maximum concentration value

Designed, manufactured and/or distributed under this quality management system

Compliant as per SVHC revision on www.commscope.com/ProductCompliance

WT-RTA12-9-96

ROHS Compliant/Exempted

UK-ROHS Compliant/Exempted

