

HST-BCANC1100NU000



HST, NOVUX™ Prodigy™ Hardened Standard Terminal, 12-port, Armored cable, 1100 ft/335 m, Universal mounting bracket

- NOVUX™ Prodigy™ Hardened Multi-port Terminals incorporate Hardened connector technology that is designed to withstand the rugged outside plant environment
- Hardened connectors are factory-integrated and environmentally sealed for use in optical drop cable deployments
- Plug and play adapter ports ensure rapid cable installment in the outside plant access section of the network
- NOVUX™ Prodigy™ HST terminals are available with 2 to 12 ports and can be utilized in Single Fiber Point-to-Point (P2P) solutions
- Available with flat dielectric, flat toneable/locatable dielectric, armored or 5mm round cable
- NOVUX™ Prodigy™ smaller terminal size for aesthetics and allowing installation in constrained spaces
- NOVUX™ Prodigy™ terminals are available in Black (RAL# 9005) or Gray (RAL# 7035)
- CommScope Product ID plate with QR code link to product documents and C-Track

Product Classification

Regional Availability	Asia EMEA Latin America North America
Product Type	Access terminal, without splitter/tap
Product Brand	NOVUX™
Product Series	HST
Minimum Order Quantity	1

General Specifications

Cable Type	Armored - Round - Loose Tube
Cable, quantity	1
Distribution Type	12 ports
Drop Port Type	Hardened Prodigy SC/APC
Drop Port, quantity	12
Enclosure Color	Black (RAL 9005)
Mounting	Handhole Pedestal Pole Strand
Port Type	Hardened Prodigy SC/APC
Port, quantity	12
Stub Type	Stub tail

HST-BCANC1100NU000

Dimensions

Height	80 mm 3.15 in
Width	128 mm 5.039 in
Length	207 mm 8.15 in
Cable Length, stub	1100 ft (335 m)
Cable Outer Diameter	3.0 mm (0.12 in)

Dimension Drawing

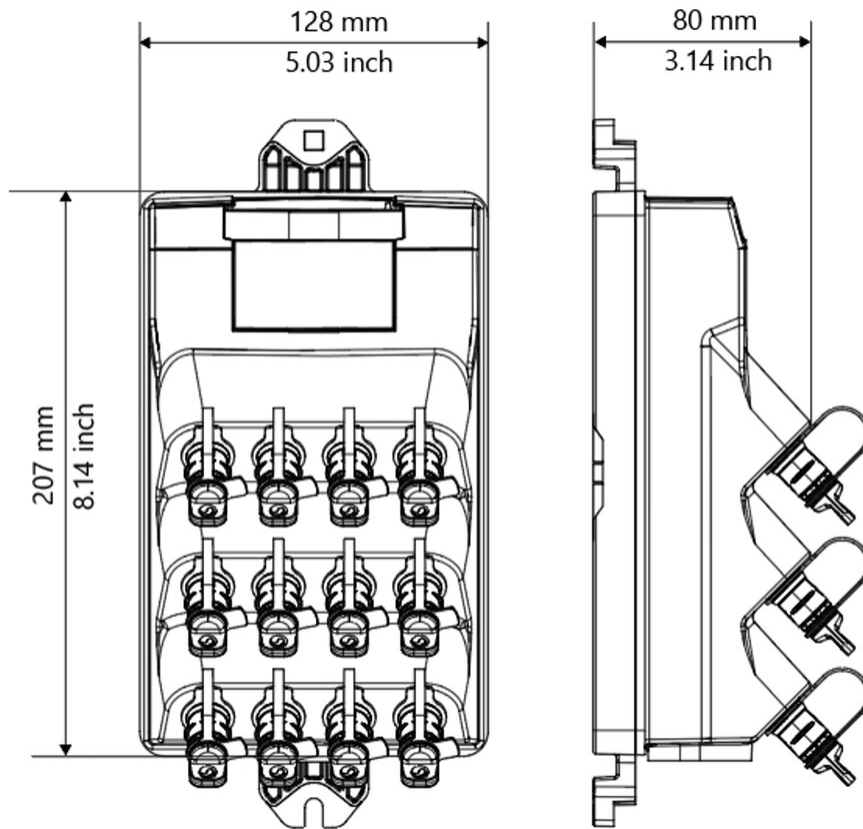

Port Configuration

NOVUX HT	TECHNOLOGIES AVAILABLE	SMALL	MEDIUM	LARGE
HST Series	Single-fiber: P2P/no splitters	2 ports	6 ports	12 ports
		4 ports	8 ports	
	Single-fiber: P2P w/splitters	2 ports, 1x1:2	8 ports, 2x1:4	12 ports, 3x1:4
		4 ports, 1x1:4	8 ports, 1x1:8	
	Hybrid for multi-use		7 ports, 1x1:4 splitter, 3 P2P	12 ports, 1x1:8 splitter, 4 P2P
		4 ports, 1x1:2 splitter, 2 P2P	8 ports, 1x1:4 splitter, 4 P2P	11 ports, 2x1:4 splitter, 2 P2P, 1 HMFOC 4f

HST-BCANC1100NU000

Ordering Tree



Material Specifications

Enclosure Material Type Hardened plastic

Optical Specifications

Fiber Type G.657.A1/A2

Operating Wavelength Range 1260 – 1635 nm

Attenuation Single Ports, maximum 0.4 dB

Attenuation Cable Coefficient, maximum 0.30 dB/km @ 1550 nm | 0.40 dB/km @ 1310 nm

Return Loss, Connector, typical 65 dB

Environmental Specifications

Operating Temperature -40 °C to +65 °C (-40 °F to +149 °F)

Relative Humidity 5%–100%, condensing

Environmental Space Above ground | Below ground

HST-BCANC1100NU000

Qualification Standards

IEC 61753-1, category G | IEC 61753-111-08 (this represents an IEC 60529 IP68 intrusion protection level)

UV Resistance

UV stabilized

Packaging and Weights

Included

Universal mounting bracket

Packaging quantity

1

Packaging Type

Box | Universal spool, wood: terminal is on the top of the spool, stub deploys first

Regulatory Compliance/Certifications

Agency**Classification**

CHINA-ROHS

Below maximum concentration value

ISO 9001:2015

Designed, manufactured and/or distributed under this quality management system

REACH-SVHC

Compliant as per SVHC revision on www.commscope.com/ProductCompliance

ROHS

Compliant

UK-ROHS

Compliant

