

HMT-BCM2A2000NN000



NOVUX™ Hardened Multi-fiber Terminal, 12 HMFOC ports, 2 fibers per port, Dielectric flat loose tube cable, 2000 ft/609 m

- NOVUX™ Hardened Multi-fiber Terminals incorporate hardened connector technology that is designed to withstand the rugged outside plant environment
- Hardened connectors are factory-integrated and environmentally sealed for use in optical drop cable deployments
- Plug and play adapter ports ensure rapid cable installment in the outside plant access section of the network
- NOVUX™ HMT terminals are well suited for fiber-rich applications and available with 12 or 24 Fibers; no internal splitter option
- Available with flat dielectric up to 24 fiber or flat toneable/locatable up to 12 fiber. Terminals can be used as a distribution point within a network or as a final multifiber drop terminal where more than a single fiber is required to service an SFU or cellular tower
- NOVUX™ smaller terminal size for aesthetics and allowing installation in constrained spaces
- NOVUX™ terminals are available in Black (RAL# 9005) or Gray (RAL# 7035)
- CommScope Product ID plate with QR code link to product documents and C-Track

Product Classification

Regional Availability	Asia EMEA Latin America North America
Product Type	Access terminal, without splitter/tap
Product Brand	NOVUX™
Product Series	HMT
Minimum Order Quantity	1

General Specifications

Cable Type	Dielectric - Flat - Loose Tube
Cable, quantity	1
Distribution Type	12 ports, 2 fibers per port
Drop Port Type	Hardened multi-fiber (HMFOC) jack, male/pinned
Enclosure Color	Black (RAL 9005)
Multi-fiber Port Type	Hardened multi-fiber (HMFOC) jack, male/pinned
Multi-fiber Port, quantity	12
Mounting	Handhole Pedestal Pole Strand
Port Type	Hardened multi-fiber (HMFOC) jack, male/pinned
Port, quantity	12

HMT-BCM2A2000NN000

Stub Type

Stub tail

Dimensions

Height

80 mm | 3.15 in

Width

128 mm | 5.039 in

Length

207 mm | 8.15 in

Cable Length, stub

2000 ft (609 m)

Dimension Drawing

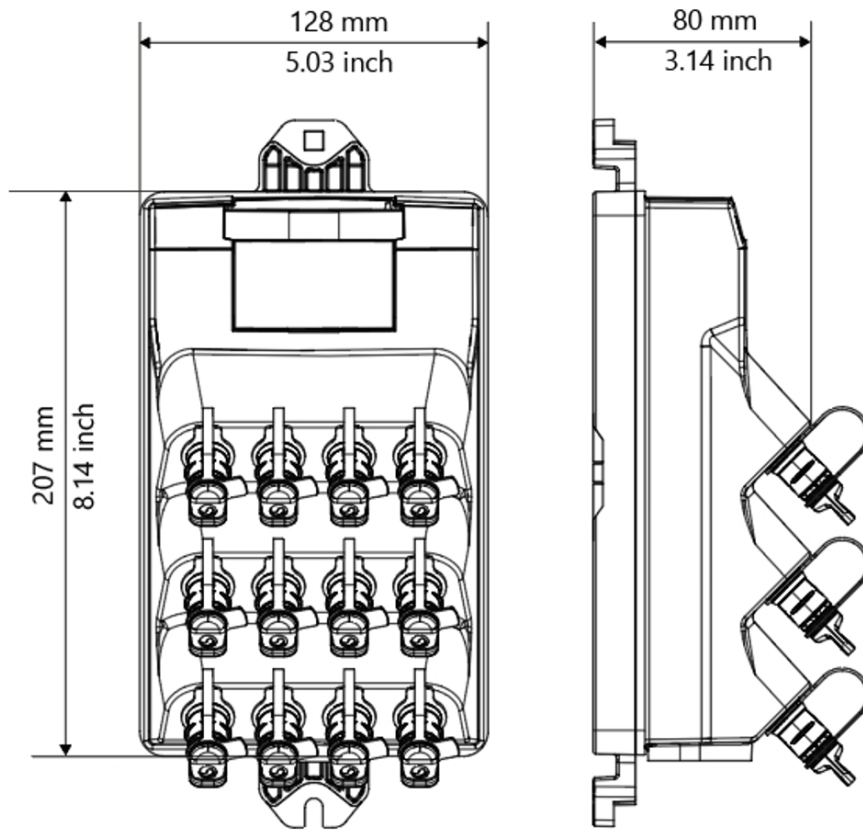

Port Configuration

NOVUX HT	TECHNOLOGIES AVAILABLE	SMALL	MEDIUM	LARGE
HMT Series	Multi-fiber	Up to 24f	Up to 24f	Up to 24f
		2 ports, each 2, 4, 6, 8 or 12f	6 ports, each 2, 3 or 4f	12 ports, each 2f
		3 ports, each 2, 4, 6, or 8f	8 ports 2 or 3f	
		4 ports, each 2, 4, or 6f		

Ordering Tree

HMT-BCM2A2000NN000

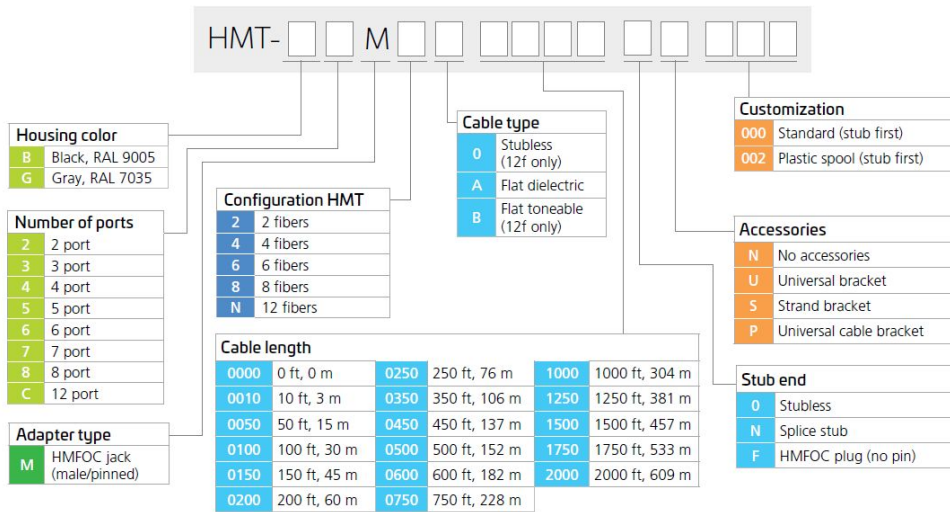

Material Specifications

Enclosure Material Type Hardened plastic

Optical Specifications

Operating Wavelength Range 1260 – 1635 nm

Attenuation Single Ports, maximum 0.65 dB

Attenuation Cable Coefficient, maximum 0.30 dB/km @ 1550 nm | 0.40 dB/km @ 1310 nm

Return Loss, Connector, typical 65 dB

Environmental Specifications

Operating Temperature -40 °C to +65 °C (-40 °F to +149 °F)

Relative Humidity 5%–100%, condensing

Environmental Space Above ground | Below ground

Qualification Standards IEC 60529, IP68 + 2 m waterhead | IEC 61753-1, category G

UV Resistance UV stabilized

Packaging and Weights

Packaging quantity 1

Packaging Type Box | Universal spool, wood: terminal is on the top of the spool, stub deploys first

Regulatory Compliance/Certifications

HMT-BCM2A2000NN000

Agency

CHINA-ROHS

ISO 9001:2015

REACH-SVHC

ROHS

UK-ROHS

Classification

Below maximum concentration value

Designed, manufactured and/or distributed under this quality management system

Compliant as per SVHC revision on www.commscope.com/ProductCompliance

Compliant

Compliant

