

HMT-B2M6B0600NU000



NOVUX™ Hardened Multi-fiber Terminal, 2 HMFOC ports, 6 fibers per port, Flat toneable loose tube cable, 600 ft/182 m, with universal mounting bracket

- NOVUX™ Hardened Multi-fiber Terminals incorporate hardened connector technology that is designed to withstand the rugged outside plant environment
- Hardened connectors are factory-integrated and environmentally sealed for use in optical drop cable deployments
- Plug and play adapter ports ensure rapid cable installment in the outside plant access section of the network
- NOVUX™ HMT terminals are well suited for fiber-rich applications and available with 12 or 24 Fibers; no internal splitter option
- Available with flat dielectric up to 24 fiber or flat toneable/locatable up to 12 fiber. Terminals can be used as a distribution point within a network or as a final multifiber drop terminal where more than a single fiber is required to service an SFU or cellular tower
- NOVUX™ smaller terminal size for aesthetics and allowing installation in constrained spaces
- NOVUX™ terminals are available in Black (RAL# 9005) or Gray (RAL# 7035)
- CommScope Product ID plate with QR code link to product documents and C-Track

Product Classification

Regional Availability	Asia EMEA Latin America North America
Product Type	Access terminal, without splitter/tap
Product Brand	NOVUX™
Product Series	HMT
Minimum Order Quantity	1

General Specifications

Cable Type	Toneable - Flat - Loose Tube
Cable, quantity	1
Distribution Type	2 ports, 6 fibers per port
Drop Port Type	Hardened multi-fiber (HMFOC) jack, male/pinned
Enclosure Color	Black (RAL 9005)
Multi-fiber Port Type	Hardened multi-fiber (HMFOC) jack, male/pinned
Multi-fiber Port, quantity	2
Mounting	Handhole Pedestal Pole Strand
Port Type	Hardened multi-fiber (HMFOC) jack, male/pinned

HMT-B2M6B0600NU000

Port, quantity	2
Stub Type	Stub tail
Dimensions	
Height	80 mm 3.15 in
Width	79 mm 3.11 in
Length	161 mm 6.339 in
Cable Length, stub	600 ft (182 m)

Dimension Drawing

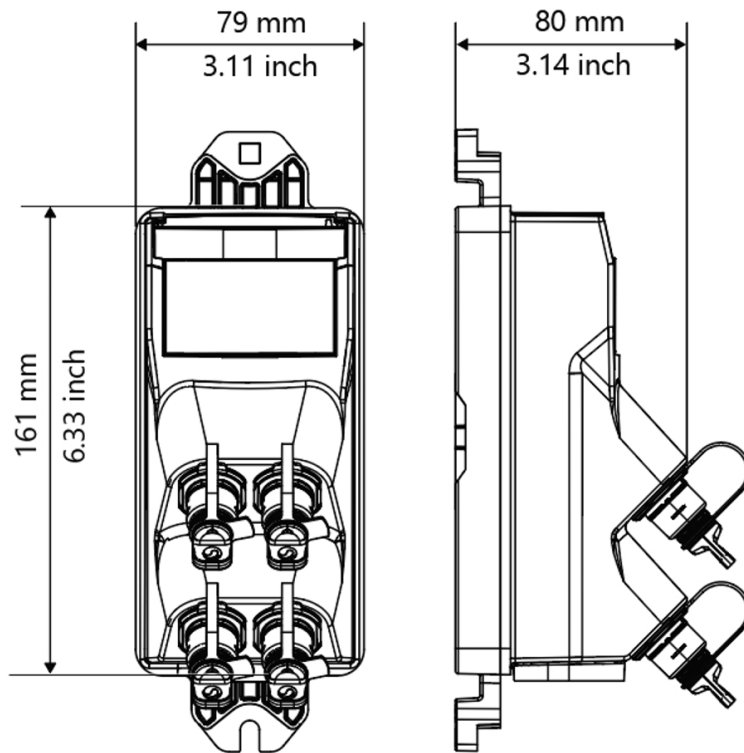

Port Configuration

NOVUX HT	TECHNOLOGIES AVAILABLE	SMALL	MEDIUM	LARGE
HMT Series	Multi-fiber	Up to 24f	Up to 24f	Up to 24f
		2 ports, each 2, 4, 6, 8 or 12f	6 ports, each 2, 3 or 4f	12 ports, each 2f
		3 ports, each 2, 4, 6, or 8f	8 ports 2 or 3f	
		4 ports, each 2, 4, or 6f		

Ordering Tree

HMT-B2M6B0600NU000

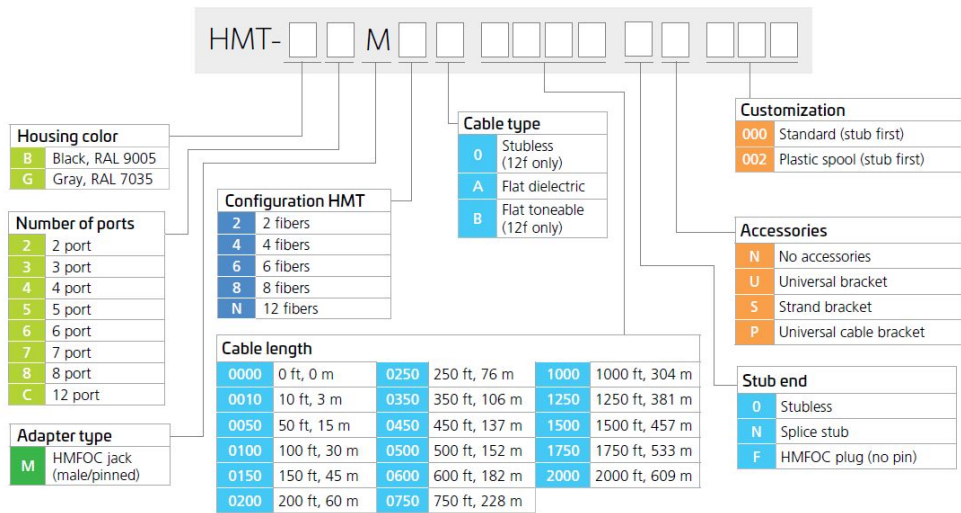

Material Specifications

Enclosure Material Type Hardened plastic

Optical Specifications

Operating Wavelength Range 1260 – 1635 nm

Attenuation Single Ports, maximum 0.65 dB

Attenuation Cable Coefficient, maximum 0.30 dB/km @ 1550 nm | 0.40 dB/km @ 1310 nm

Return Loss, Connector, typical 65 dB

Environmental Specifications

Operating Temperature -40 °C to +65 °C (-40 °F to +149 °F)

Relative Humidity 5%–100%, condensing

Environmental Space Above ground | Below ground

Qualification Standards IEC 60529, IP68 + 2 m waterhead | IEC 61753-1, category G

UV Resistance UV stabilized

Packaging and Weights

Included Universal mounting bracket

Packaging quantity 1

Packaging Type Box | Universal spool, wood: terminal is on the top of the spool, stub deploys first

HMT-B2M6B0600NU000

Regulatory Compliance/Certifications

Agency**Classification**

CHINA-ROHS

Below maximum concentration value

ISO 9001:2015

Designed, manufactured and/or distributed under this quality management system

REACH-SVHC

Compliant as per SVHC revision on www.commscope.com/ProductCompliance

ROHS

Compliant

UK-ROHS

Compliant

