

# HMT-B2M4A0500NN000



NOVUX™ Hardened Multi-fiber Terminal, 2 HMFOC ports, 4 fibers per port, Dielectric flat loose tube cable, 500 ft/152 m

- NOVUX™ Hardened Multi-fiber Terminals incorporate hardened connector technology that is designed to withstand the rugged outside plant environment
- Hardened connectors are factory-integrated and environmentally sealed for use in optical drop cable deployments
- Plug and play adapter ports ensure rapid cable installment in the outside plant access section of the network
- NOVUX™ HMT terminals are well suited for fiber-rich applications and available with 12 or 24 Fibers; no internal splitter option
- Available with flat dielectric up to 24 fiber or flat toneable/locatable up to 12 fiber. Terminals can be used as a distribution point within a network or as a final multifiber drop terminal where more than a single fiber is required to service an SFU or cellular tower
- NOVUX™ smaller terminal size for aesthetics and allowing installation in constrained spaces
- NOVUX™ terminals are available in Black (RAL# 9005) or Gray (RAL# 7035)
- CommScope Product ID plate with QR code link to product documents and C-Track

## Product Classification

<b>Regional Availability</b>	Asia   EMEA   Latin America   North America
<b>Product Type</b>	Access terminal, without splitter/tap
<b>Product Brand</b>	NOVUX™
<b>Product Series</b>	HMT
<b>Minimum Order Quantity</b>	1

## General Specifications

<b>Cable Type</b>	Dielectric - Flat - Loose Tube
<b>Cable, quantity</b>	1
<b>Distribution Type</b>	2 ports, 4 fibers per port
<b>Drop Port Type</b>	Hardened multi-fiber (HMFOC) jack, male/pinned
<b>Enclosure Color</b>	Black (RAL 9005)
<b>Multi-fiber Port Type</b>	Hardened multi-fiber (HMFOC) jack, male/pinned
<b>Multi-fiber Port, quantity</b>	2
<b>Mounting</b>	Handhole   Pedestal   Pole   Strand
<b>Port Type</b>	Hardened multi-fiber (HMFOC) jack, male/pinned
<b>Port, quantity</b>	2

# HMT-B2M4A0500NN000

## Stub Type

Stub tail

## Dimensions

<b>Height</b>	80 mm   3.15 in
<b>Width</b>	79 mm   3.11 in
<b>Length</b>	161 mm   6.339 in
<b>Cable Length, stub</b>	500 ft (152 m)

## Dimension Drawing

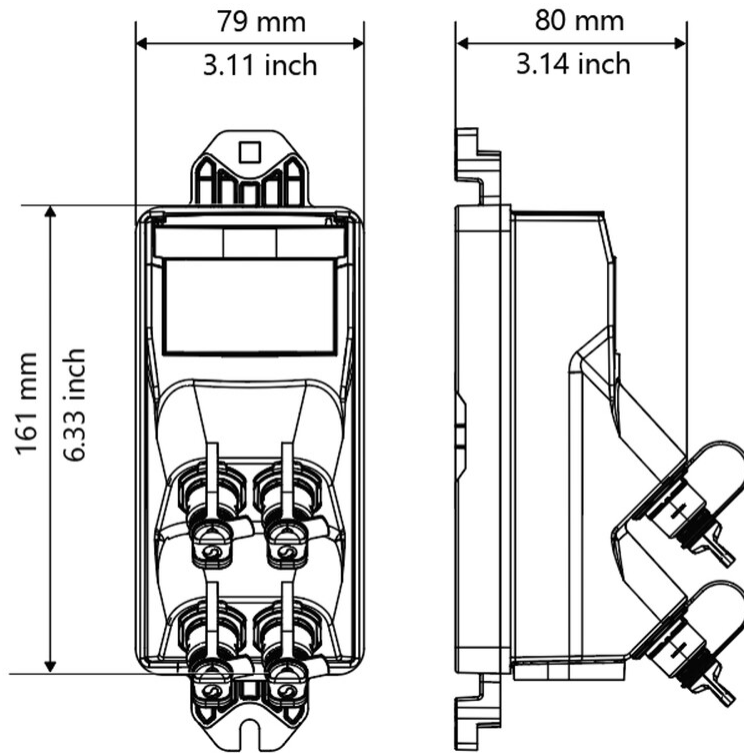

## Port Configuration

NOVUX HT	TECHNOLOGIES AVAILABLE	SMALL	MEDIUM	LARGE
HMT Series	Multi-fiber	Up to 24f	Up to 24f	Up to 24f
		2 ports, each 2, 4, 6, 8 or 12f	6 ports, each 2, 3 or 4f	12 ports, each 2f
		3 ports, each 2, 4, 6, or 8f	8 ports 2 or 3f	
		4 ports, each 2, 4, or 6f		

## Ordering Tree



# HMT-B2M4A0500NN000

---

## Regulatory Compliance/Certifications

<b>Agency</b>	<b>Classification</b>
CHINA-ROHS	Below maximum concentration value
ISO 9001:2015	Designed, manufactured and/or distributed under this quality management system
REACH-SVHC	Compliant as per SVHC revision on <a href="http://www.commscope.com/ProductCompliance">www.commscope.com/ProductCompliance</a>
ROHS	Compliant
UK-ROHS	Compliant

