

# FL1-G7/01GC1-122



FL1000 Fiber Wall Box, 2-door, singlemode SC/UPC, 12 ports, with indoor /outdoor black jacket cable, stub at far end, 122 meters

- Ideal for small to medium fiber counts within communication rooms or closets at customer sites
- Provides demarcation access for the telecom carrier and the end-user by way of separate compartments
- Guarantees mechanical protection and fiber management for indoor and outdoor cable
- Fully customizable for patch-patch, splice-patch or for the storage of un-terminated (dark) fibers

## Product Classification

<b>Regional Availability</b>	North America
<b>Product Type</b>	Fiber wall box
<b>Product Series</b>	FL1000

## General Specifications

<b>Application</b>	Patching
<b>Adapter Packs Included, quantity</b>	2
<b>Adapters, quantity</b>	12
<b>Cable Clamps, quantity</b>	1
<b>Cable Entry Location</b>	Bottom left   Bottom right   Top left   Top right
<b>Cable Type</b>	IFC - Stranded
<b>Color</b>	Putty white
<b>Door, quantity</b>	2
<b>Front Door Type</b>	Single hinged
<b>Growth Configuration</b>	Fully loaded
<b>Interface</b>	SC/UPC
<b>Lock Type</b>	Key lock
<b>Mounting</b>	Wall
<b>Total Fibers, quantity</b>	12
<b>Total Ports, quantity</b>	12

## Dimensions

<b>Height</b>	433 mm   17.047 in
<b>Width</b>	511 mm   20.118 in

# FL1-G7/01GC1-122

<b>Depth</b>	156.97 mm   6.18 in
<b>Cable Length</b>	229 m   751.312 ft

## Outline Drawing

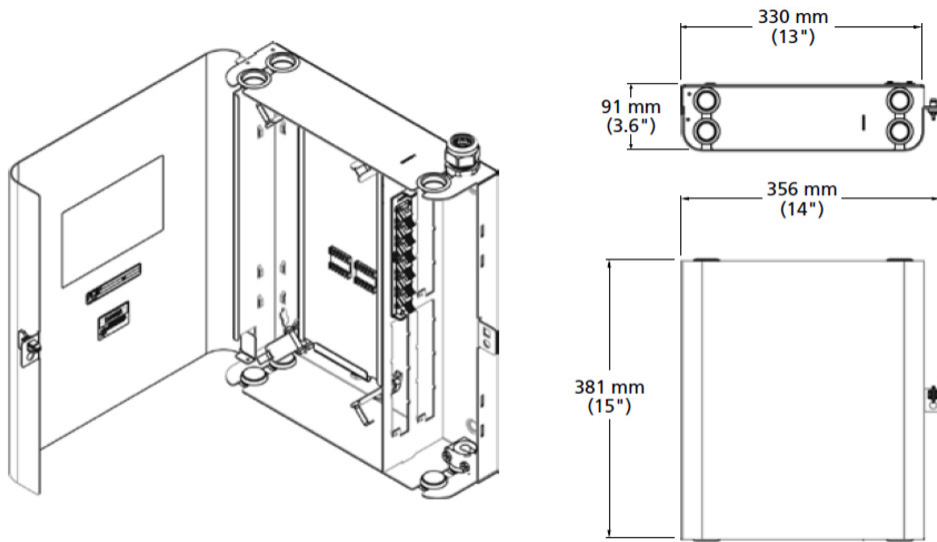

## Material Specifications

<b>Finish</b>	Powder coated
<b>Material Type</b>	Steel

## Optical Specifications

<b>Fiber Mode</b>	Singlemode
-------------------	------------

## Environmental Specifications

<b>Environmental Space</b>	Indoor
<b>Qualification Standards</b>	NEMA type 12

## Packaging and Weights

<b>Packaging quantity</b>	1
<b>Packaging Type</b>	Bag   Carton