

E14F15P03



Single Quadplexer 700-800//900//1800//2100-2600 MHz, with 4.3-10 connectors,dc bypass on port 2

- Industry leading PIM performance
- Designed for network modernization application, introduction of LTE700 and LTE800 on existing site
- New 4.3-10 connectors for improved PIM performance and size reduction
- Suitable for feeders cables reduction

Product Classification

Product Type Quadplexer

General Specifications

Color Gray

Modularity 2-Twin

Mounting Pole | Wall

Mounting Pipe Hardware Band clamps (2)

RF Connector Interface 4.3-10 Female

RF Connector Interface Body Style Medium neck

Dimensions

Height 263 mm | 10.354 in

Width 328 mm | 12.913 in

Depth 64 mm | 2.52 in

Mounting Pipe Diameter Range 42.6–122 mm

Electrical Specifications

Impedance 50 ohm

License Band, Band Pass APT 700 | CEL 850 | CEL 900 | DCS 1800 | EDD 800 | IMT 2100 | IMT 2600 | LMR 800 | LMR 900 | TDD 2300

License Band, LNA DCS 1800

Electrical Specifications, dc Power/Alarm

dc/AISG Pass-through, combiner Branch 2

dc/AISG Pass-through, demultiplexer Branch 2

E14F15P03

Lightning Surge Current	5 kA
Lightning Surge Current Waveform	8/20 waveform

Electrical Specifications, AISG

AISG Carrier	2176 KHz \pm 100 ppm
Insertion Loss, maximum	1 dB
Return Loss, minimum	10 dB

Electrical Specifications

Sub-module	1 2	1 2	1 2	1 2
Branch	1	2	3	4
Port Designation	PORT 1 694-862	PORT 2 880-960	PORT 3 1710-1880	PORT 4 1920-2170 2300-2690
License Band	APT 700, Band Pass CEL 850, Band Pass EDD 800, Band Pass LMR 800, Band Pass	CEL 900, Band Pass LMR 900, Band Pass	DCS 1800, LNA	IMT 2600, Band Pass IMT 2100, Band Pass TDD 2300, Band Pass

Electrical Specifications, Band Pass

Frequency Range, MHz	694–862	880–960	1710–1880	1920–2170 2300–2690
Insertion Loss, typical, dB	0.3	0.3	0.25	0.25
Return Loss, typical, dB	22	22	22	22
Isolation, minimum, dB	50	50	50	50
Input Power, RMS, maximum, W	300	300	300	300
Input Power, PEP, maximum, W	3000	3000	3000	3000
3rd Order PIM, typical, dBc	-160	-160	-160	-160
3rd Order PIM Test Method	Two +43 dBm carriers	Two +43 dBm carriers	Two +43 dBm carriers	Two +43 dBm carriers

Block Diagram

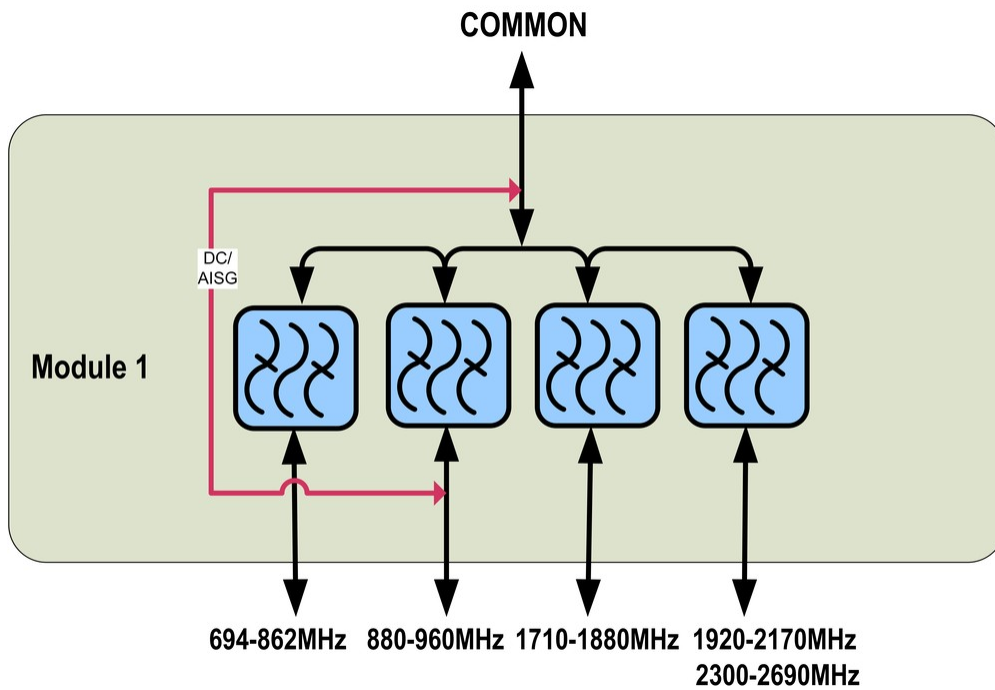

Mechanical Specifications

Wind Speed, maximum 216 km/h | 134.216 mph

Environmental Specifications

Operating Temperature -40 °C to +65 °C (-40 °F to +149 °F)

Relative Humidity 15%–100%

Corrosion Test Method IEC 60068-2-11, 30 days

Ingress Protection Test Method IEC 60529:2001, IP67

Vibration Test Method IEC 60068-2-6

Packaging and Weights

Included Mounting hardware

Weight, net 6.6 kg | 14.55 lb