

ITEM	PART NO.	DESCRIPTION	QTY.	WEIGHT
1	MT1972401	24" SINGLE SUPPORT ARM	1	55.07 LBS
2	MT197H	HARDWARE KIT (ITEM 3)	1	
3	GB-0524A	5/8" X 2-1/2" GALV BOLT KIT (A325)	4	0.53 LBS

REVISIONS				
REV.	ZONE	DESCRIPTION	BY	DATE
A		INITIAL RELEASE	MSM	11/20/09

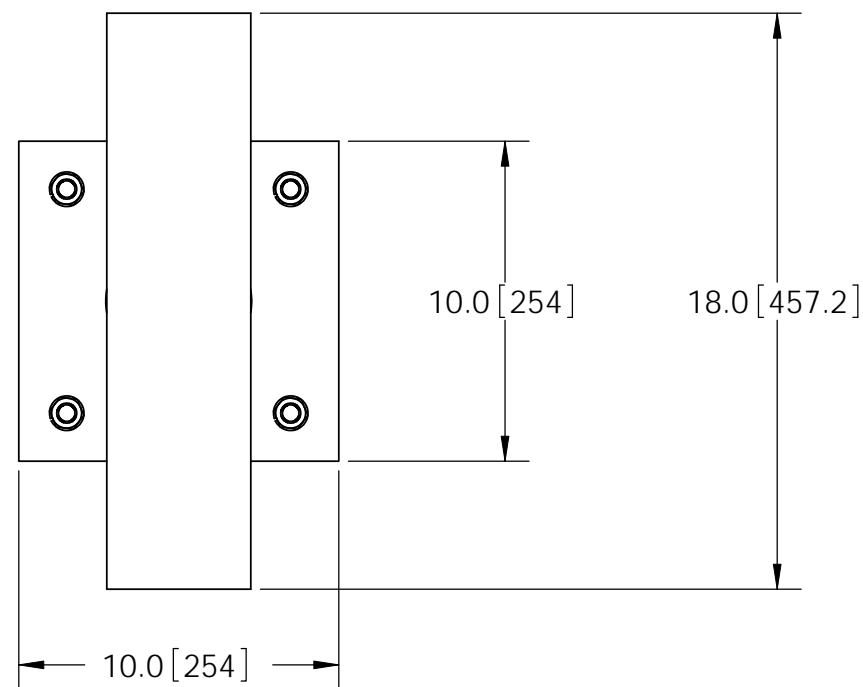
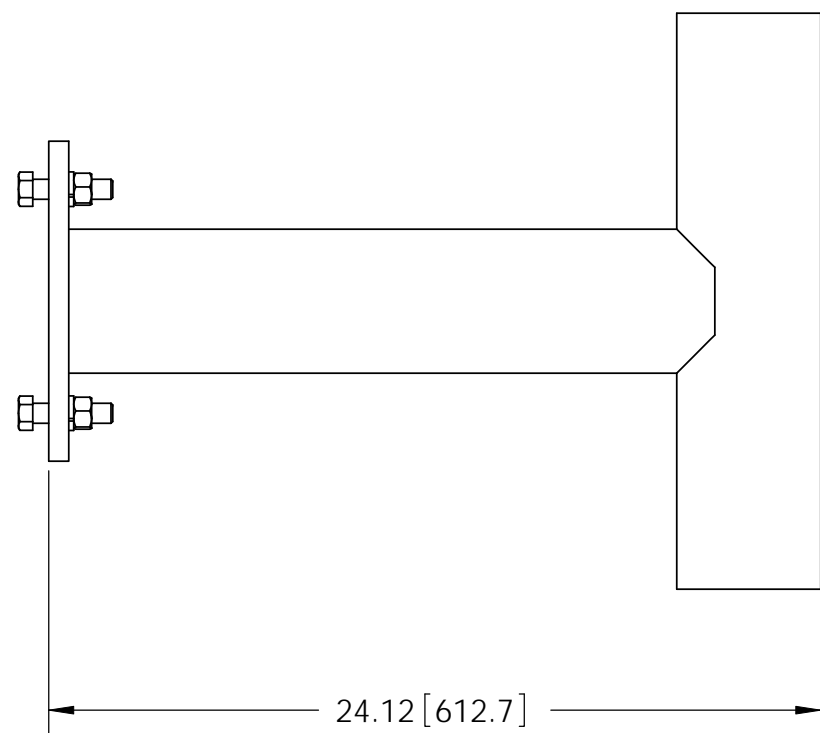
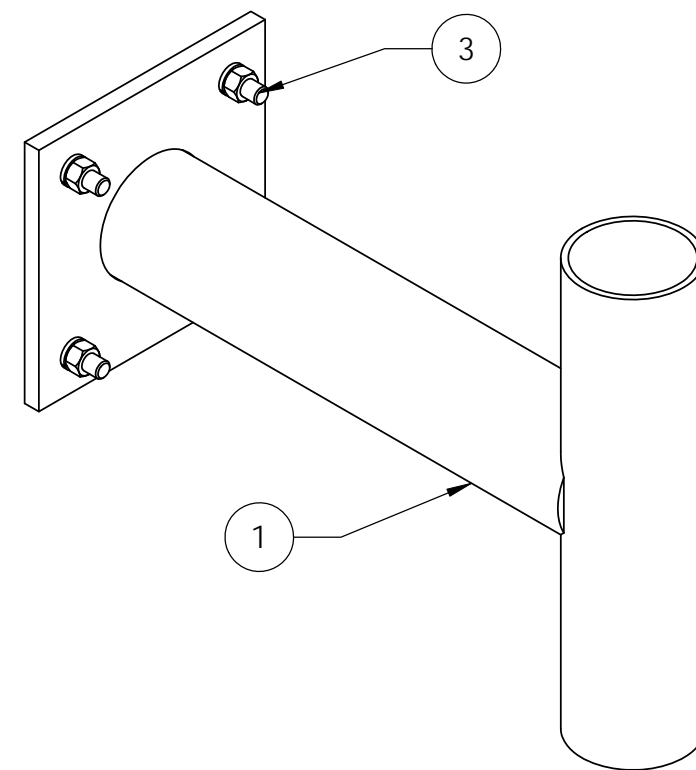
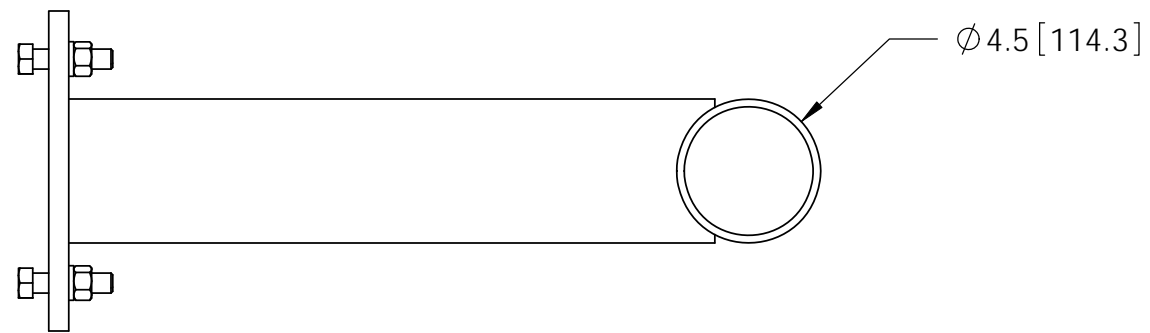

NOTES:  
1. ALL METRIC DIMENSIONS ARE IN BRACKETS.

<small>These drawings and specifications are the proprietary property of ANDREW CORPORATION and may be used only for the specific purpose authorized in writing by Andrew Corporation.</small> ALL DIMENSIONS ARE IN INCHES U.O.S. TOLERANCES UNLESS OTHERWISE SPECIFIED: .X = ± .12      ANGLES      ±2° .XX = ± .06      FRACTIONS      ±1/32 .XXX = ± .03 REMOVE BURRS AND BREAK EDGES .005 DO NOT SCALE THIS PRINT	DRAWN BY: MSM	SHEET: 1 of 1	PART NUMBER: MT-197-24
	CHECKED BY: TP	SCALE: NTS	DESCRIPTION: 24" SINGLE SUPPORT ARM KIT
	DATE: 11/20/09	MATERIAL: A36, A53	DRAWING TYPE: ASSEMBLY DRAWING
	REVISION: A	FINISH: GALV A123	WEIGHT: 56.75 LBS