

MST-12XX00-A0800U



DLX® Mini-MST, Fiber Optic Multiport Service Terminal, 12-port, dielect. flat loose tube cable, 800 ft

- Hardened connectors are factory-terminated and environmentally sealed for use in optical drop cable deployments
- Plug and play adapter ports ensure rapid cable installment in the outside plant access section of the network
- Multiport Service Terminals incorporate hardened connector technology that is designed to withstand the rugged outside plant environment

Product Classification

Regional Availability	Asia Latin America North America
Product Type	Access terminal, without splitter/tap
Product Brand	DLX®
Product Series	Mini-MST

General Specifications

Cable Type	Dielectric - Flat - Loose Tube
Cable, quantity	1
Distribution Type	12 ports
Enclosure Color	Black
Mounting	Handhole Pedestal Pole Strand
Port Type	Hardened mini-size DLX
Port, quantity	12
Splitter, quantity	0
Stub Type	Stub tail

Dimensions

Height	298 mm 11.732 in
Width	130.3 mm 5.13 in
Depth	89 mm 3.504 in
Cable Length, stub	800 ft (243 m)
Cable Outer Diameter	4.5 x 8.1 mm (0.18 x 0.32 in)

MST-12XX00-A0800U

Dimension Drawing

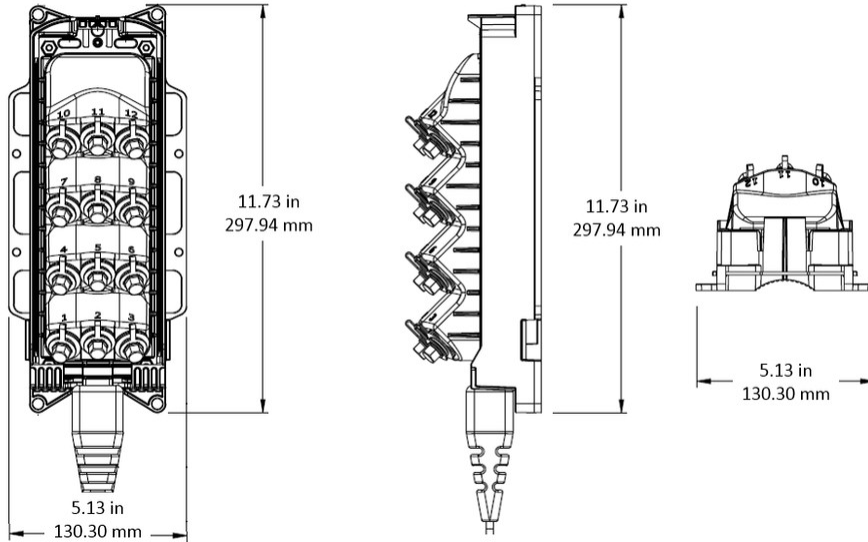

Ordering Tree

MST - X - - - -

Terminal model

02	2 ports
04	4 ports
06	6 ports
08	8 ports
12	12 ports
0N	1 x 4 splitter
0J	1 x 8 splitter
0W	1 x 2 splitter

Cable termination

00	Pigtail (No connector)
X0	DLX connector (only available on splitter terminals)

Cable type

A	Dielectric, flat, loose tube (44.3mm x 8.0mm)
B	Locatable/tonable, flat, loose tube (44.3mm x 10.0mm)

Mounting style*

U	Universal: Terminal is on top of the spool; stub deploys first
A	Reversal Spool: Terminal is on the bottom of the spool; terminal deploys first

*0-300 ft lengths of cable is automatically coiled (option U), for lengths greater than 300 feet choose U or A option.

Standard cable stub length

0050	50 feet	1000	1,000 feet
0100	100 feet	1250	1,250 feet
0250	250 feet	1500	1,500 feet
0500	500 feet	1750	1,750 feet
0750	750 feet	2000	2,000 feet

Standard lengths shown; metric lengths available

Material Specifications

Enclosure Material Type

Gasketed hardened plastic

Optical Specifications

Fiber Type

G.657.A1/A2

MST-12XX00-A0800U

Operating Wavelength Range	1260 – 1635 nm
Attenuation Cable Coefficient, maximum	0.30 dB/km @ 1550 nm 0.40 dB/km @ 1310 nm
Attenuation Terminal Connectors, maximum	0.4 dB
Directivity, minimum	60 dB
Insertion Loss, Terminal Connector, typical	0.16 dB
Return Loss, Connector, minimum	65 dB

Environmental Specifications

Operating Temperature	-40 °C to +70 °C (-40 °F to +158 °F)
Relative Humidity	5%–100%, condensing
Environmental Space	Above ground Below ground Buried
Flammability Rating	UL 94 V-0
Qualification Standards	IEC 60529, IP68 + 2 m waterhead Telcordia GR-3120-CORE Telcordia GR-326-CORE Telcordia GR-771-CORE
UV Resistance	UV stabilized

Packaging and Weights

Included	Enclosure (1) Universal mounting bracket (1)
Packaging quantity	1
Packaging Type	Box Carton
Weight, without cable	0.99 kg 2.183 lb

Regulatory Compliance/Certifications

Agency	Classification
CHINA-ROHS	Below maximum concentration value
ISO 9001:2015	Designed, manufactured and/or distributed under this quality management system
REACH-SVHC	Compliant as per SVHC revision on www.commscope.com/ProductCompliance
ROHS	Compliant
UK-ROHS	Compliant



Included Products

MST-UMB-MINI – DLX® Mini-MST, Fiber Optic Universal Mounting

MST-12XX00-A0800U

Bracket

MST-UMB-MINI



DLX® Mini-MST, Fiber Optic Universal Mounting Bracket

Product Classification

Regional Availability	EMEA Latin America North America
Product Type	Mounting bracket
Product Brand	DLX®
Product Series	Mini-MST

General Specifications

Color	Black
--------------	-------

Environmental Specifications

Environmental Space	Outdoor
----------------------------	---------

Packaging and Weights

Packaging quantity	1
Packaging Type	Bag Carton

Regulatory Compliance/Certifications

Agency	Classification
CHINA-ROHS	Below maximum concentration value
REACH-SVHC	Compliant as per SVHC revision on www.commscope.com/ProductCompliance
ROHS	Compliant
UK-ROHS	Compliant

