

Fiber Indoor Cable, Plenum All-Dielectric Central Tube Ribbon, 60-fiber, Multimode OM3 bend insensitive, Feet jacket marking, Aqua jacket color

## Product Classification

<b>Regional Availability</b>	Asia   Australia/New Zealand   Latin America   Middle East /Africa   North America
<b>Portfolio</b>	CommScope®
<b>Product Type</b>	Fiber indoor cable
<b>Product Series</b>	P-CN

## General Specifications

<b>Cable Type</b>	Ribbon central tube
<b>Construction Type</b>	Non-armored
<b>Subunit Type</b>	Gel-free
<b>Fibers per Ribbon, quantity</b>	12
<b>Jacket Color</b>	Aqua
<b>Jacket Marking</b>	Feet
<b>Total Fiber Count</b>	60

## Dimensions

<b>Buffer Tube/Subunit Diameter</b>	6 mm   0.236 in
<b>Diameter Over Jacket</b>	9.2 mm   0.362 in

## Representative Image

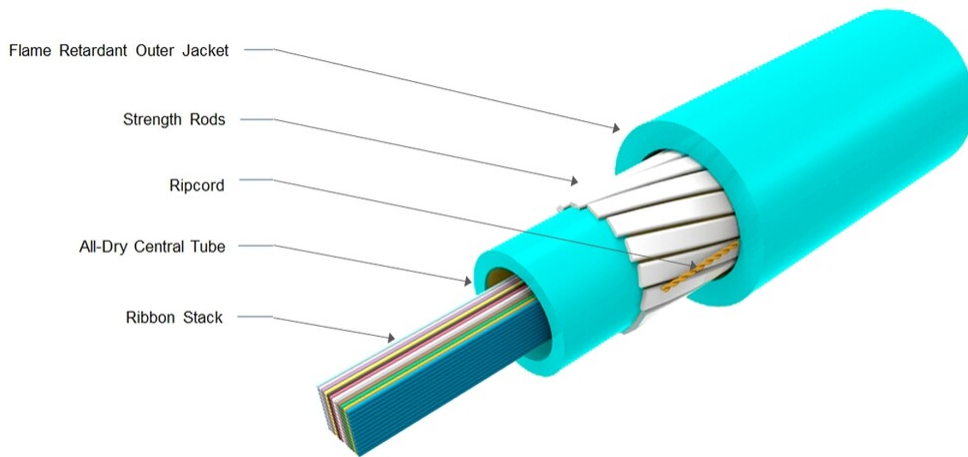

## Mechanical Specifications

<b>Minimum Bend Radius, loaded</b>	182.9 mm   7.201 in
<b>Minimum Bend Radius, unloaded</b>	91.4 mm   3.598 in
<b>Tensile Load, long term, maximum</b>	334 N   75.086 lbf
<b>Tensile Load, short term, maximum</b>	1335 N   300.12 lbf
<b>Compression</b>	10 N/mm   57.101 lb/in
<b>Compression Test Method</b>	FOTP-41   IEC 60794-1 E3
<b>Flex</b>	25 cycles
<b>Flex Test Method</b>	FOTP-104   IEC 60794-1 E6
<b>Impact</b>	2.94 N-m   26.021 in lb
<b>Impact Test Method</b>	FOTP-25   IEC 60794-1 E4
<b>Strain</b>	See long and short term tensile loads
<b>Strain Test Method</b>	FOTP-33   IEC 60794-1 E1
<b>Twist</b>	10 cycles
<b>Twist Test Method</b>	FOTP-85   IEC 60794-1 E7

## Optical Specifications

<b>Fiber Type</b>	OM3, bend insensitive   OM3, bend insensitive
-------------------	---

## Environmental Specifications

<b>Installation temperature</b>	0 °C to +70 °C (+32 °F to +158 °F)
<b>Operating Temperature</b>	-20 °C to +70 °C (-4 °F to +158 °F)

# 760232637 | P-060-CN-RB-F12AQ/5Y/99E

---

<b>Storage Temperature</b>	-40 °C to +70 °C (-40 °F to +158 °F)
<b>Cable Qualification Standards</b>	ANSI/ICEA S-83-596   Telcordia GR-409
<b>Environmental Space</b>	Plenum
<b>Flame Test Listing</b>	NEC OFNP (UL) and c(UL)
<b>Flame Test Method</b>	NFPA 130   NFPA 262

## Environmental Test Specifications

<b>Heat Age</b>	-20 °C to +85 °C (-4 °F to +185 °F)
<b>Heat Age Test Method</b>	IEC 60794-1 F9
<b>Low High Bend</b>	0 °C to +70 °C (+32 °F to +158 °F)
<b>Low High Bend Test Method</b>	FOTP-37   IEC 60794-1 E11
<b>Temperature Cycle</b>	-20 °C to +70 °C (-4 °F to +158 °F)
<b>Temperature Cycle Test Method</b>	FOTP-3   IEC 60794-1 F1

## Packaging and Weights

<b>Cable weight</b>	85 kg/km   57.117 lb/kft
---------------------	--------------------------

## Regulatory Compliance/Certifications

<b>Agency</b>	<b>Classification</b>
ISO 9001:2015	Designed, manufactured and/or distributed under this quality management system

## Included Products

CS-5Y-RB	- 50µm OM3 Bend-Insensitive Multimode Fiber
----------	---

## \* Footnotes

**Operating Temperature** Specification applicable to non-terminated bulk fiber cable

# CS-5Y-RB

---

## 50µm OM3 Bend-Insensitive Multimode Fiber

### Product Classification

<b>Portfolio</b>	CommScope®
<b>Product Type</b>	Optical fiber

### General Specifications

<b>Cladding Diameter</b>	125 µm
<b>Cladding Diameter Tolerance</b>	±1.0 µm
<b>Cladding Non-Circularity, maximum</b>	1 %
<b>Coating Diameter (Colored)</b>	250 µm
<b>Coating Diameter (Uncolored)</b>	245 µm
<b>Coating Diameter Tolerance (Colored)</b>	±15 µm
<b>Coating Diameter Tolerance (Uncolored)</b>	±10 µm
<b>Coating/Cladding Concentricity Error, maximum</b>	12 µm
<b>Core Diameter</b>	50 µm
<b>Core Diameter Tolerance</b>	±3 µm
<b>Core/Clad Offset, maximum</b>	1 µm
<b>Proof Test</b>	689.476 N/mm <sup>2</sup>   100000 psi

### Mechanical Specifications

<b>Macrobending, 15 mm Ø mandrel, 2 turns</b>	0.20 dB @ 850 nm   0.50 dB @ 1,300 nm
<b>Macrobending, 30 mm Ø mandrel, 2 turns</b>	0.10 dB @ 850 nm   0.30 dB @ 1,300 nm
<b>Coating Strip Force, maximum</b>	8.9 N   2.001 lbf
<b>Coating Strip Force, minimum</b>	1.3 N   0.292 lbf
<b>Dynamic Fatigue Parameter, minimum</b>	18

### Optical Specifications

<b>Numerical Aperture</b>	0.2
<b>Numerical Aperture Tolerance</b>	±0.015
<b>Point Defects, maximum</b>	0.2 dB
<b>Zero Dispersion Slope, maximum</b>	0.105 ps/[km-nm-nm]
<b>Zero Dispersion Wavelength, maximum</b>	1340 nm

# CS-5Y-RB

---

**Zero Dispersion Wavelength, minimum** 1295 nm

## Optical Specifications, Wavelength Specific

<b>Attenuation, maximum</b>	1.50 dB/km @ 1,300 nm   3.50 dB/km @ 850 nm
<b>Backscatter Coefficient</b>	-68.0 dB @ 850 nm   -75.7 dB @ 1,300 nm
<b>Bandwidth, Laser, minimum</b>	2,000 MHz-km @ 850 nm   500 MHz-km @ 1,300 nm
<b>Bandwidth, OFL, minimum</b>	1,500 MHz-km @ 850 nm   500 MHz-km @ 1,300 nm
<b>Differential Mode Delay Note</b>	Superior to TIA-492AAAC and IEC 60793-2-10 at 850 nm
<b>Index of Refraction</b>	1.478 @ 1,300 nm   1.482 @ 850 nm
<b>Standards Compliance</b>	TIA-492AAAC (OM3)

## Environmental Specifications

<b>Heat Aging, maximum</b>	0.10 dB/km @ 85 °C
<b>Temperature Dependence, maximum</b>	0.1 dB/km
<b>Temperature Humidity Cycling, maximum</b>	0.1 dB/km
<b>Water Immersion, maximum</b>	0.10 dB/km @ 23 °C

## Regulatory Compliance/Certifications

<b>Agency</b>	<b>Classification</b>
ISO 9001:2015	Designed, manufactured and/or distributed under this quality management system

## \* Footnotes

<b>Temperature Dependence, maximum</b>	Temperature dependence is conducted at -60 °C to +85 °C (-76 °F to +185 °F)
<b>Temperature Humidity Cycling, maximum</b>	Temperature humidity cycling is conducted at -10 °C to +85 °C (+14 °F to +185 °F) up to 95% relative humidity