

Corner Wall Mount, 2-3/8 in OD x 96 in pipe

Product Classification

Product Type Wall mount kit

Dimensions

Height 609.6 mm | 24.0 in
Length 2438.4 mm | 96.0 in
Pipe Outer Diameter 60.3 mm | 2 3/8 in
Weight 60.6 kg | 133.6 lb
Width 1219.2 mm | 48.0 in

Environmental Specifications

Wind Rating For Specifications, please contact steelproducts@commscope.com or call 800-255-1479

General Specifications

Mounting Walls
Includes Brackets (2) | Pipe mounts | Wall mount hardware
Material Type Hot dip galvanized steel
Package Quantity 1
Pipe Length 2438.4 mm | 96.0 in
Pipe, quantity 1

Outline Drawing

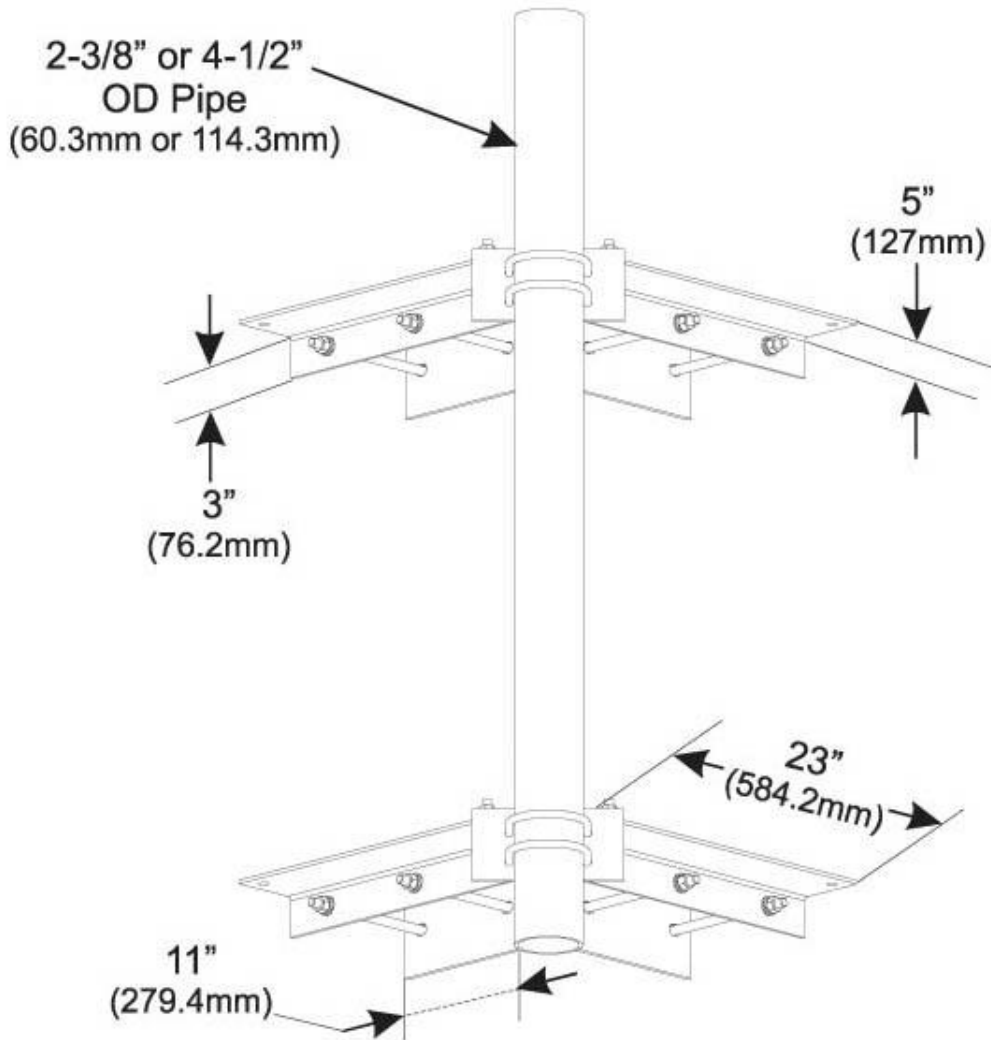

Regulatory Compliance/Certifications

Agency	Classification
ISO 9001:2015	Designed, manufactured and/or distributed under this quality management system



Included Products

MT-651-96 — Plain End Pipe, 2-3/8 in OD x 96 in

* Footnotes

Wind Rating

BWS—Base Wind Speed; FBC—Florida Building Code

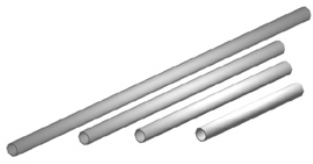

Plain End Pipe, 2-3/8 in OD x 96 in

Product Classification

Product Type Plain end pipe

Dimensions

Pipe Outer Diameter 60.3 mm | 2 3/8 in
Height 60.3 mm | 2.4 in
Length 2438.4 mm | 96.0 in
Weight 15.2 kg | 33.5 lb
Width 60.3 mm | 2.4 in

General Specifications

Material Type Hot dip galvanized steel
Pipe Length 2438.4 mm | 96.0 in
Includes Pipe
Package Quantity 1
Pipe, quantity 1

Regulatory Compliance/Certifications

Agency ISO 9001:2015
Classification Designed, manufactured and/or distributed under this quality management system

