



GS3 Pedestal Closure - AC Non-encapsulated

INSTALLATION INSTRUCTION

GS3 1650 Cold-Applied Pedestal Splice Closure

Closure Size Chart

GS3-PED-Kit:	Main Cable Pair Range	Stub Cable Pair Range	Max. Splice Opening
GS3-PED-Kit-25-100-N	25 - 100	0 - 50	12"
GS3-PED-Kit-100-300-N	100 - 300	0 - 100	18"
GS3-PED-Kit-300-600-N	300 - 600	25 - 200	21"

1.0 General Product Information

This practice provides information regarding the installation of CommScope GS3 cold-applied pedestal splice closure system. The GS3 wrap-around splice closure system provides a fast, simple way to seal telephone cable splices in nonpressurized cable spliced in a pedestal.

GS3 closure sealing sheet material is composed of several layers of specially blended polymers and gels, and an aluminum moisture vapor barrier layer. The outer compression wrap provides excellent mechanical strength and provides superior protection from forces such as impact and abrasion.

2.0 Warnings

The alcohol cleaning tissue in this kit is **FLAMMABLE**. Keep away from heat and open flame.

3.0 General Installation Notes

1. Use temporary bonding procedures where required.
2. The GS3 closure should be installed when the temperature in the work area is above 0°F (-18°C).
3. Do not use the GS3 closure on pressurized plant or pulp cable.
4. Do not place the GS3 closure on a wet splice. Thoroughly dry the splice in accordance with your company-approved practices. Be sure that no water comes in contact with the splice during installation.
5. Use only company-approved connectors and bonding hardware.

4.0 Kit Components

The GS3 pedestal closure kit contains the following components:

- 2 sealant strips
- 1 cleaning tissue
- 1 tie wrap
- 1 gel sealing sheet
- 1 roll compression wrap
- 1 sealant "apple core"

5.0 Installation Instructions

1. Remove cable sheath and shield from the cable. See Figure 1.
2. Install approved bond clamps with the solid ground wire connected to the clamps. Complete splice work.

NOTE: Do not use stranded bond wire or braided bond strap. If using insulated ground wire, remove 4 inches of insulation from the top of the ground wire.

3. Cut off the excess bond stud and file away any remaining sharp edges. Isolate each bond clamp by wrapping with vinyl or DR tape.
4. Clean all cable jackets with the cleaning tissue.
5. Arrange cables in a triangle with the smallest cable in front. See Figure 2.
6. Place the sealant "apple core" just below the previously installed bond clamps with the two larger cables in the core's cable openings (Fig. 3).
7. If present, press the third cable into the front and center of the apple core (Fig. 3).
8. Press the ground wires into the apple core directly in front of each main cable. (Fig. 3)
9. Start sealant strip provided 1" past the large cable. Wrap it around the apple core and Z-fold sealant (see Figure 4) between both ground wires and small cable to eliminate voids. If needed, wrap second sealant strip around the apple core. Tightly compress all cables together by hand to eliminate any other voids. (Fig. 4)

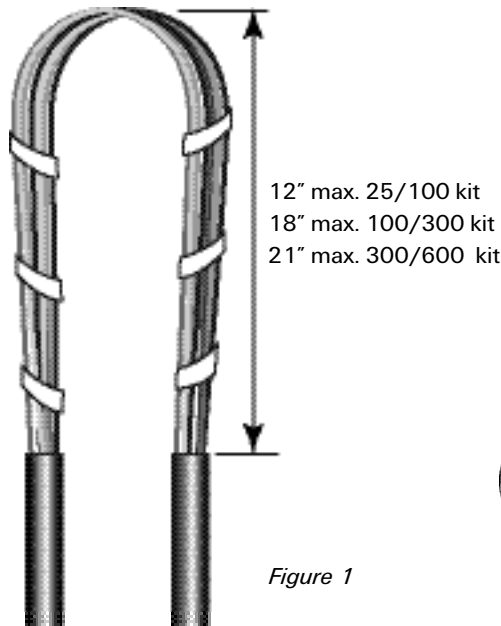

Figure 1

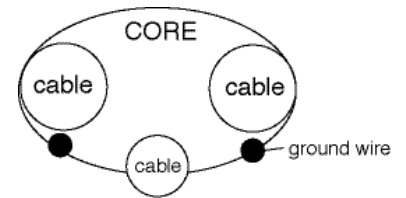

Figure 2

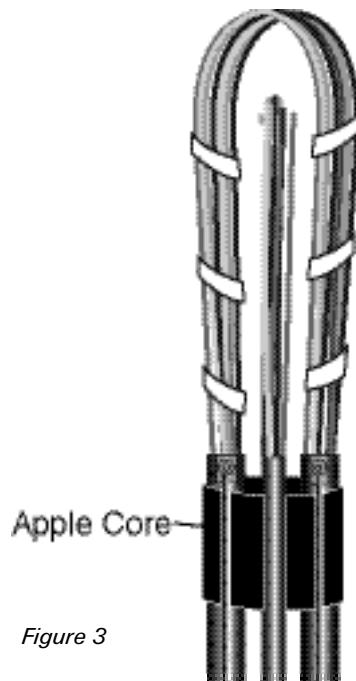

Figure 3

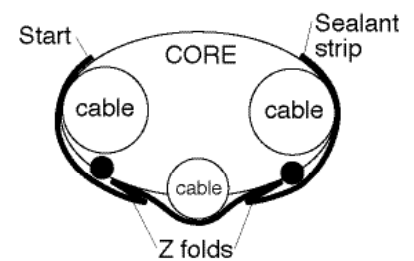

Figure 4

For GS3 25/100 Closure Only:

10. Starting at the apple core, tightly wrap 3 or 4 layers of 3-mil splice wrap around the apple core. Continue with a half-lapped wrap to the top of the splice, and back down 3" below the apple core, then back up to the apple core. Secure the 3-mil splice wrap with vinyl tape. (Fig. 5)
11. To form gel bag, fold gel sheet over itself lengthwise and remove release paper. (Fig. 6)
12. Place gel bag over splice bundle making sure that the bag extends a minimum of 2" past the apple core. Excess bag length can be cut off.
13. Fold excess gel bag as shown in Figure 7 and tape in place.

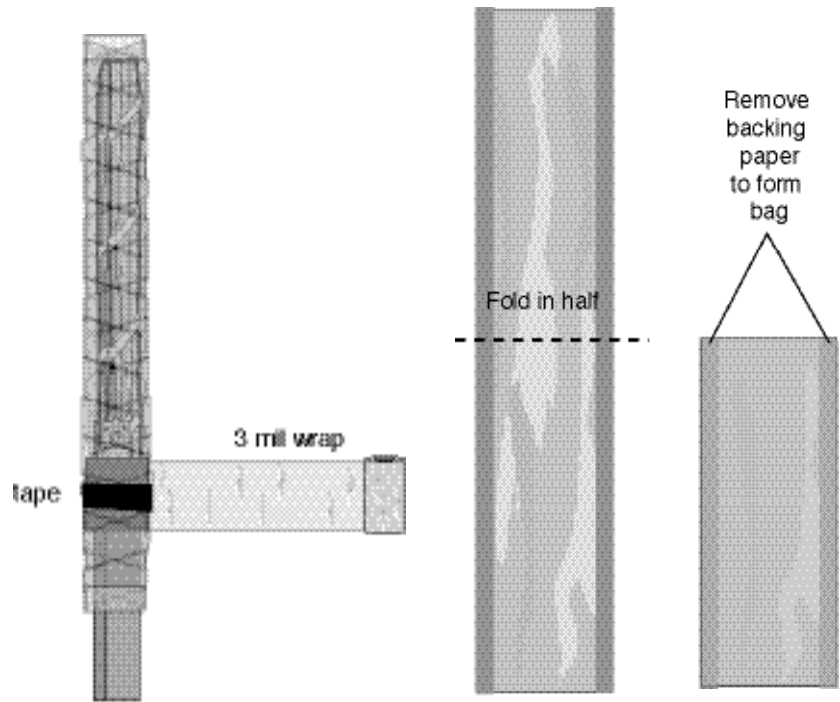

Figure 5

Figure 6

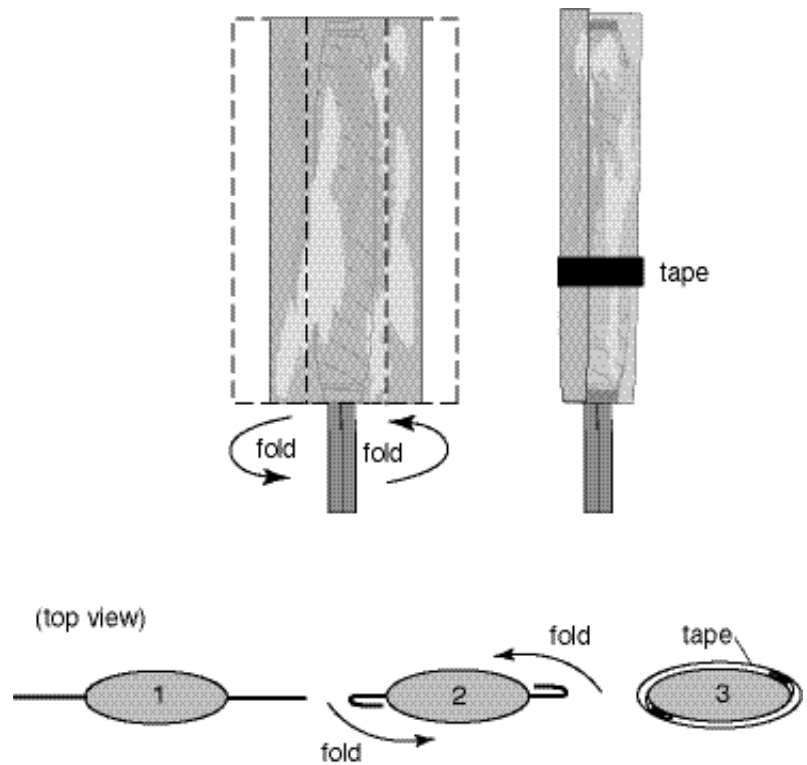

Figure 7

For GS3 100/300 and 300/600 Kits Only

10. Starting at the apple core, tightly wrap 3 or 4 layers of 3-mil splice wrap around the apple core. Continue with a half-lapped wrap to the top of the splice, and back down 3" below the apple core, then back up to the apple core. Secure the 3-mil splice wrap with vinyl tape.
11. To form gel bag, fold gel sheet over itself widthwise and remove release paper. See Figure 8.
12. Place gel bag over splice making sure that the bag extends at least 2" past the apple core and 4" above the top of the splice.
13. Fold excess gel bag as shown in Figure 9 and tape in place.

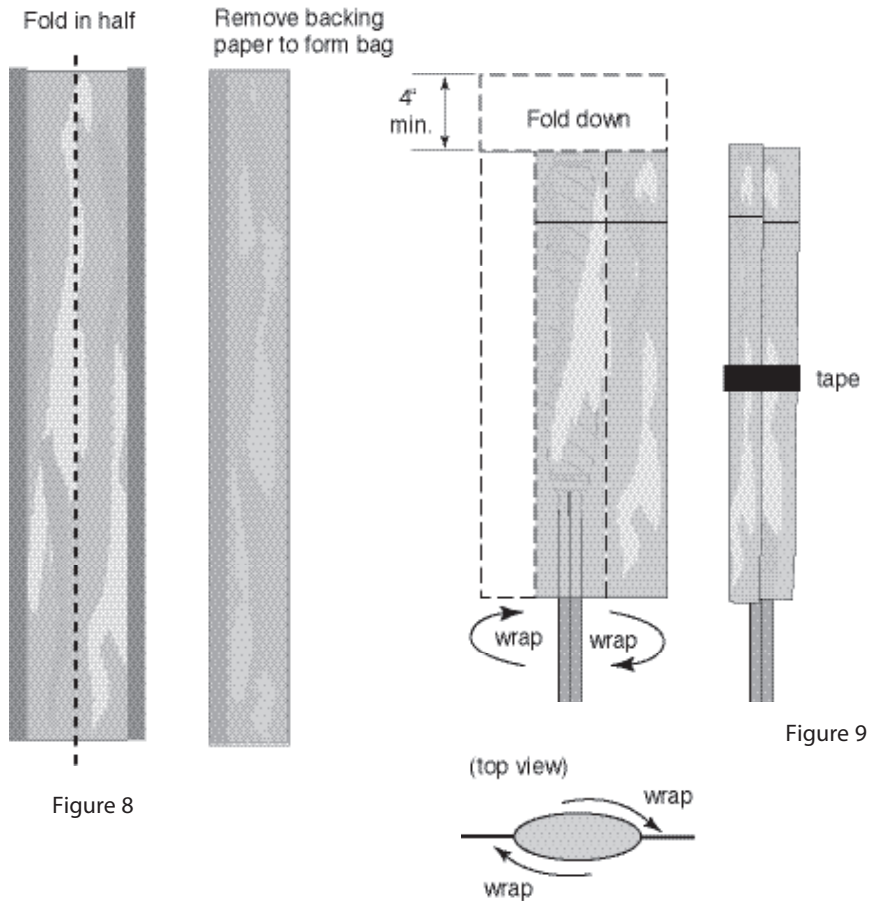

Figure 8

Figure 9

For All Kits:

14. Cut two or more 6" strips of compression wrap. Form an "X" on top of bag and tape in place. (Fig. 10)
15. Starting at the top of the gel bag, begin wrapping the compression wrap securely around the splice in half-lapped layers. Wrap the compression wrap 1" past the bottom of the gel bag and continue back to the top, stopping 6" from the bottom. (Fig. 11)
16. Cut off excess compression wrap and tape in place with vinyl tape. Use the enclosed tie-wrap to hold in place.

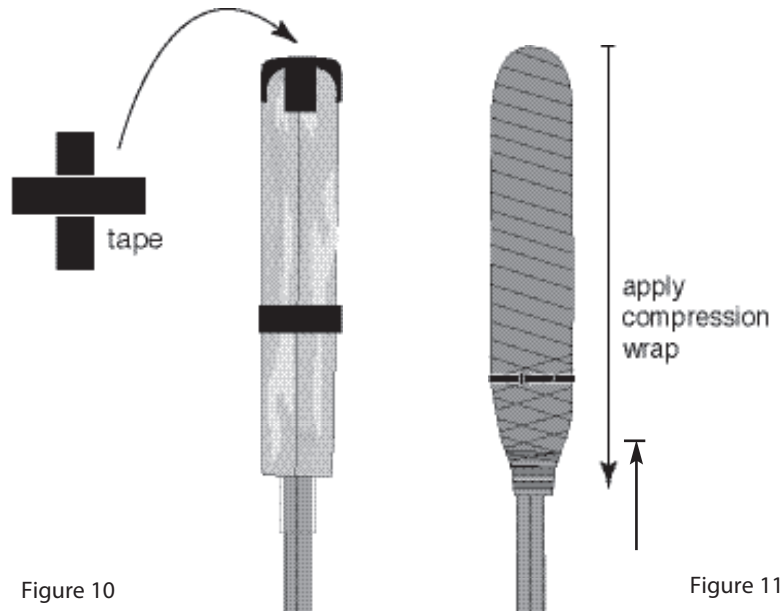

Figure 10

Figure 11

GS3, CommScope, and the CommScope logo are trademarks.

The information given herein, including drawings, illustrations and schematics which are intended for illustration purposes only, is believed to be reliable. However, CommScope makes no warranties as to its accuracy or completeness and disclaims any liability in connection with its use. CommScope obligations shall only be as set forth in CommScope Standard Terms and Conditions of Sale for this product and in no case will CommScope be liable for any incidental, indirect or consequential damages arising out of the sale, resale, use or misuse of the product. Users of CommScope products should make their own evaluation to determine the suitability of each such product for the specific application.

Technical Assistance Center (TAC)
Tel.: 800.830.5056
Email: TAC.Americas@commscope.com
www.commscope.com