

GELSNAP Copper Closure, unpressurized, gel sealed, butt/in-line, for up to 10 pair splices

- Prevents water ingress by use of non-flowing gel under permanent compression
- Robust and reliable under a wide variety of environmental conditions
- Butt, in-line, and branch configurations with many connector types are possible

Product Classification

Product Type	Gel filled closure
Product Series	GELSNAP
Regional Availability	EMEA

General Specifications

Color	Black
Includes	Gel compression springs Gel-filled half-shells Installation instruction Strain relief accessories Tie wraps
Package, quantity	1
Packaging Type	Bag Carton
Single Cable Diameter, maximum	14.00 mm 0.55 in
Single Cable Diameter, minimum	5.00 mm 0.20 in
Splicing Capacity, maximum	10

Dimensions

Height	33.00 mm 1.30 in
Length	290.00 mm 11.42 in
Sheet Opening, nominal	130.00 mm 5.12 in
Width	80.00 mm 3.15 in

Dimension Drawing

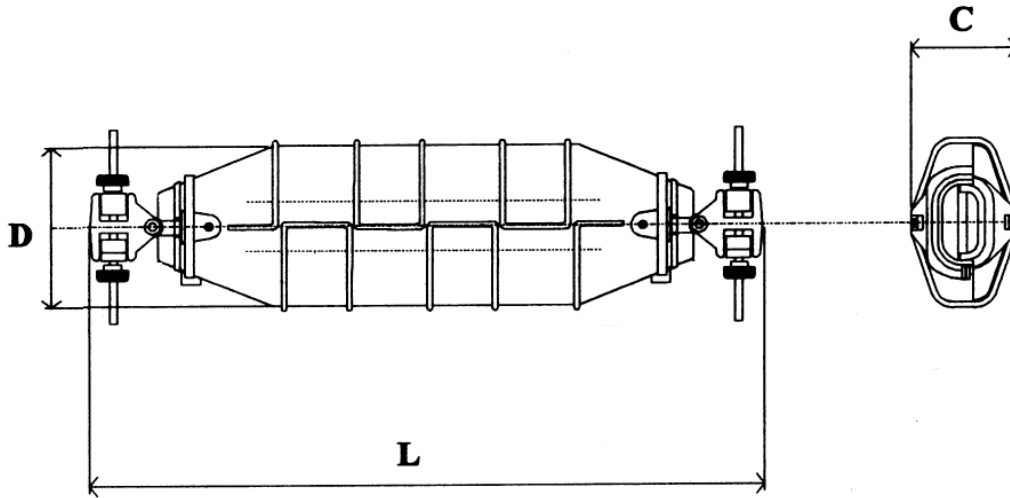

Dimension Drawing Used as an image placeholder

Mechanical Specifications

Cable Sealing Type Gel filled
Closure Style In-line | Single-ended

Environmental Specifications

Environmental Space Aerial | Buried

Regulatory Compliance/Certifications

Agency	Classification
RoHS 2011/65/EU	Compliant
ISO 9001:2015	Designed, manufactured and/or distributed under this quality management system
TL 9000:2016 (R6)	Compliant to this quality management practice

